

COMMSCOPE®

Green Agenda | **2024**
for Outdoor Wireless Networks



Mobile network operators are working hard to reduce their environmental impact. CommScope's Outdoor Wireless Networks segment is working just as hard to help them do it.

CommScope's Outdoor Wireless Networks segment (OWN) is trusted by mobile network operators (MNOs) all over the world because we build solutions that answer their RF path challenges—all their challenges. It's not always about building bigger and stronger. Sometimes it's about building smaller and smarter.

We have a special responsibility to fulfill

Mobile networks are a top consumer of electricity and a major user of finite materials like steel, copper and other mined resources that also require energy to refine, resulting in significant CO₂ release. Our MNO partners are committed to reducing these impacts, and OWN is committed to building solutions that help them reach those environmental responsibility goals.

We measure results with sound science, not sound bites

OWN doesn't deal in platitudes and vague declarations of intent. We take conscious steps in our design, materials selection, manufacturing and logistics that yield real, quantifiable results because we share our partners' belief that a greener business model is not just possible, not just desirable, but in fact a critical goal to achieve. Our partners have targets to hit—OWN provides the hard scientific data they need to know how they're doing.

In 2023 we introduced the Sustainability Value Score, a **clear, concise** and **reliable** indication of the **environmental impact** of our base station antennas

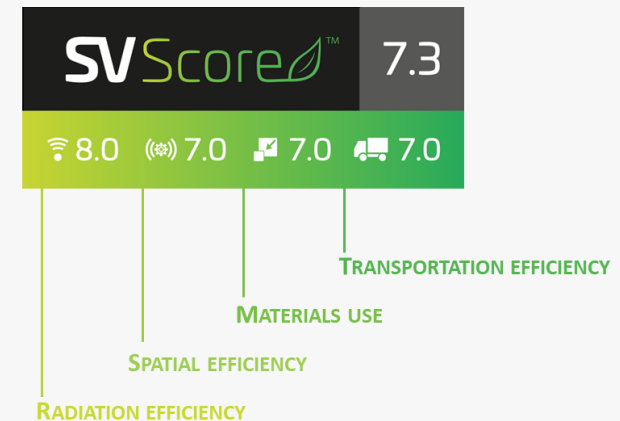

[Learn more](#)

Towards net zero communications







OWN knows there is no single solution to improving sustainability and promoting the circular economy. That's why we help our MNO partners reduce their environmental impact at every stage. Our efforts cover the entire planning, production and lifecycle of our products.

- 1** Eco-friendly design for more efficient networks through a smart use of resources
- 2** Sustainable operations and supply chain
- 3** Rethinking packaging and logistics to reduce distribution impact
- 4** Extending product lifecycles to extend the lifespan of wireless networks

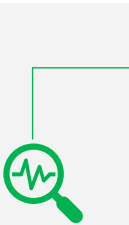
Four pillars supporting our one planet

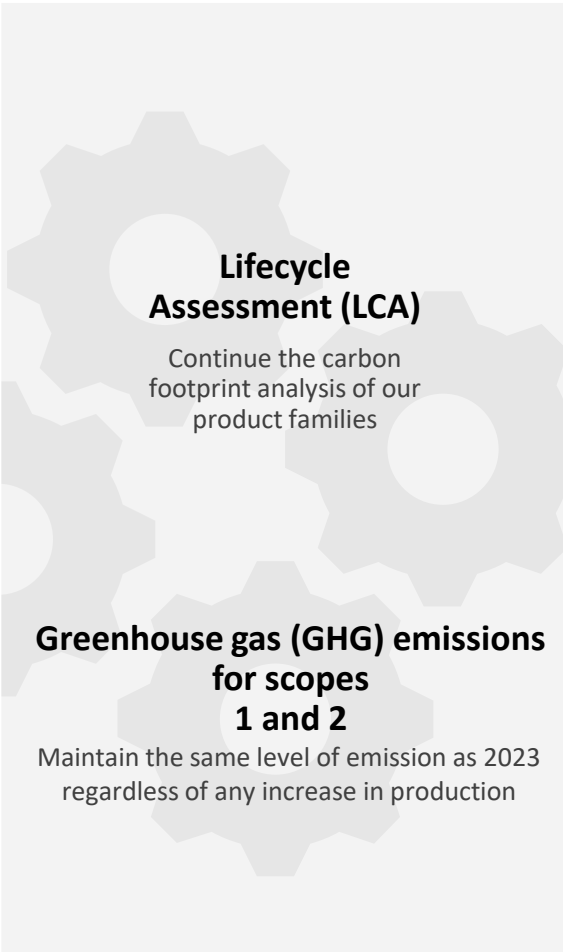
Our goals and achievements

2022	2023	2024	2030
 <p>OWN sustainability assessment and strategy validation</p> <p>Complete full assessment of all key measurables</p> <p>Greenhouse gas (GHG) emissions for scopes 1 and 2</p> <p>26% reduction from 2019 baseline (the objective was a 4% reduction)</p>	 <p>Science-based target initiatives (SBTi) implementation</p> <p>Implement strategy across all initiatives in 2023</p> <p>Greenhouse gas (GHG) emissions for scopes 1 and 2</p> <p>Achieved 21% emission reduction compared to 2022 (target was 5%) and 38% compared to 2019 baseline (target was 30%)</p> <p>Introduced SVScore™ (Sustainability Value Score)</p> <p>To measure the environmental impact of our base station antennas (BSA)</p> <p>Lifecycle Assessment (LCA)</p> <p>Completed 7 LCAs for BSA, HELIAX® solutions and structural support solutions</p>	 <p>Lifecycle Assessment (LCA)</p> <p>Continue the carbon footprint analysis of our product families</p> <p>Greenhouse gas (GHG) emissions for scopes 1 and 2</p> <p>Maintain the same level of emission as 2023 regardless of any increase in production</p>	 <p>Greenhouse gas (GHG) emissions for scopes 1 and 2</p> <p>Achieve total emission reduction of 50% from 2019 baseline</p>

Eco-friendly design

Thoughtful resource management from design to disposal

Embracing a more sustainable future means finding better ways to build solutions that connect more people while consuming less

—less metals mined, less electricity consumed, less weight transported and less material going into landfills at the end of a much longer lifecycle.

CommScope OWN fulfills our commitment to environmental sustainability in countless ways—but we’re always able to count the actual, tangible benefits they yield.

CommScope OWN embraces the circular economy

The idea of the circular economy—doing more with less, increasing efficiency, extending product lifespans and increasing recyclability in both the production and disposal of our products—is central to our design philosophy.

Feeding cell sites with renewable energy

Our advanced design incorporates a solution that combines vertical wind turbines and solar panels to harvest up to 65% renewable energy for cell sites, effectively cutting CO₂ emissions. This solution is particularly beneficial in rural areas, reducing diesel dependency and significantly reducing the need for refueling by helicopters or ATVs, thus further lessening economic and environmental impact.



CommScope OWN has the capability to customize products to meet application requirements; tailoring the product to the specific needs means a reduced amount of material and consequently a reduction of weight and wind load.

Re-design of internal BSA components:

- Reduction of reflector’s thickness and height
- Reduction of internal bracket thickness and width
- Change in the dipole material from PCB to aluminum

-70 metric tons of aluminum, steel, copper and plastics

preventing the release in the atmosphere of

1,445 metric tons of CO₂eq

We build smaller and smarter.

- **Our reduced-weight hub mounting ring** for microwave antennas has saved 2.6 tons of aluminum in manufacturing, representing 41 tons of CO₂ release prevented. 13 more tons of released CO₂ are prevented for every 1,000 antenna we build.
- **PowerShift® Macro** dynamically boosts DC voltage to remote radios, mitigating voltage losses from line resistance. It enables MNOs to avoid upgrading power trunks to larger cable sizes, avoiding the need to perform costly and material-rich upgrade projects. PowerShift Macro supports circular economy objectives in several important ways:
 - Supports high-power RRUs with minimal cable diameters
 - Enables the continued use and reuse of existing cell site cables
 - Minimizes the need for additional backup battery strings
 - Ensures the maximum utility and service life of older battery strings

We support the deployment of shared infrastructure.

- **OWN BSAs include solutions that are designed to be shared across multiple operators**, reducing the need for redundant infrastructure and promoting a lighter environmental footprint for mobile networks.
- **HELIAX® SkyBlox™ and modular connectivity solutions are designed to accommodate multiple MNOs on a single infrastructure platform**, reducing the amount of hardware that must be produced, transported, installed and maintained.
- Our HELIAX SkyBlox solution is constructed from a single polymer which is **100% recyclable**.

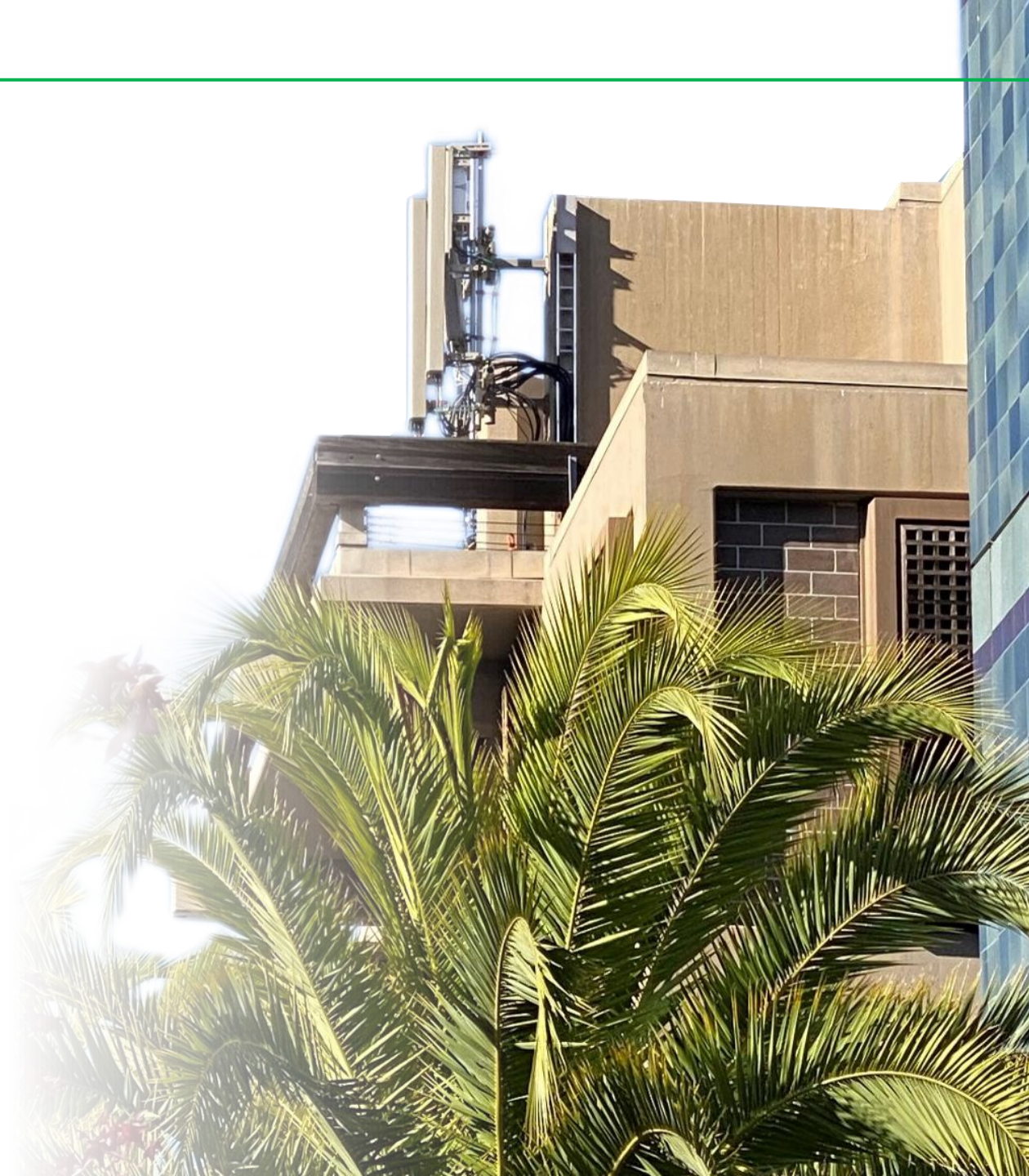

We design each new solution with recyclability in mind.

ECO-FRIENDLY DESIGN



Recyclability
100%



Weight reduction
-20% thanks to lower density

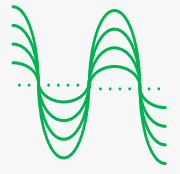

Better RF transparency
-65% insertion loss
-30% dielectric constant

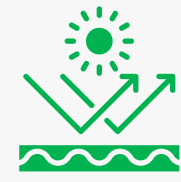

Comparable mechanical properties
1,344 hours UV resistance
>150°C heat resistance



Going behind headlines with circular economy:

Our next-gen glass fiber reinforced polypropylene (GFRPP) antenna radome is made of 100% recyclable thermoplastic instead of heavier resin-and-fiberglass designs.

In 2023 the GFRPP radome was successfully implemented in eight antenna models.

8T8R base station antennas

The right-size alternative that balances radio access network (RAN) performance and energy efficiency

CommScope offers a comprehensive portfolio of more than 80 varieties of 8T8R BSAs that provide a flexible, superefficient alternative to 32T32R and 64T64R architectures in medium- and low-density areas, yielding:

30% less power use and CO₂ release than 32T32R

- Up to 2,339 kWh energy savings per year
- As much as 535 kg less CO₂ released

50% less power use and CO₂ release than 64T64R

- Up to 5,000 kWh energy savings per year
- As much as 1,600 kg less CO₂ released

Dense urban high-rise ISD 700-2000 ft



Urban low-rise ISD 2000-3000 ft



Suburban ISD>0.6 mi



Rural ISD~3 mi



	Dense urban high-rise ISD 700-2000 ft	Urban low-rise ISD 2000-3000 ft	Suburban ISD>0.6 mi	Rural ISD~3 mi
Very high traffic	64T64R	32T32R	32T32R 16T16R	(FWA) 32T32R 16T16R
Moderate/low traffic	Not suitable	8T8R	8T8R	8T8R

Complemented with dynamic spectrum sharing (DSS) in some scenarios. In very low-traffic sites, the 3.5 GHz band will probably not be used, and the FDD bands may be sufficient.

8T8R base station antennas are **suitable in 70% to 80% of all deployments**

Energy-efficient base station antennas help reduce RAN power consumption

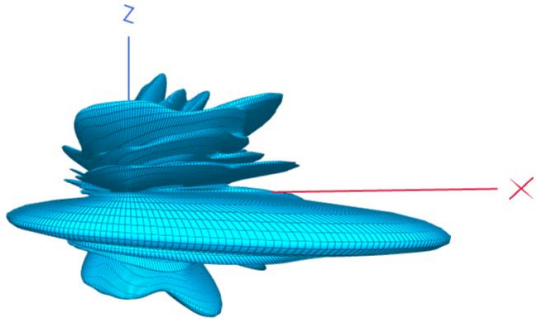

Insights into pattern efficiency

2D patterns—azimuth and elevation cuts—have historically been used to characterize a BSA. However, new 3D metrics can better represent the overall antenna pattern efficiency and improve our understanding of how antennas shape the performance of the network both in terms of coverage and capacity. CommScope designs focus on the discoveries provided by these metrics.

Well-designed BSAs can reduce overall RAN power consumption by improving *radiation* and *pattern efficiencies*. Savings that can be achieved depend on the configuration of the site, the expected traffic load and the generation of the product being replaced.

CommScope offers a wide range of energy-efficient solutions, so **operators can right-size their infrastructure investments and maximize energy savings from day one**—without locking themselves into limited options later on.

In 2023 we introduced the **SEED™ high efficiency proprietary technology** for base station antennas that improves **radiation efficiency** and enables **key operational and environmental benefits**.

At the core of SEED—which stands for *sustainable energy-efficient design*—are an innovative, low-loss distribution feed network and advanced phase-shifter technology to boost the antenna's radiated power relative to its input power. The result is an increase in the antenna's radiating efficiency.

So, MNOs have the flexibility to fill coverage gaps, especially at the cell edge or inside buildings, or reduce energy consumption by up to **15%**.



Manage intelligent power delivery

CommScope OWN embraces the evolution of cellular infrastructure power management to deliver smarter, more efficient electrical service to ensure networks can perform as needed, without wasting watts.

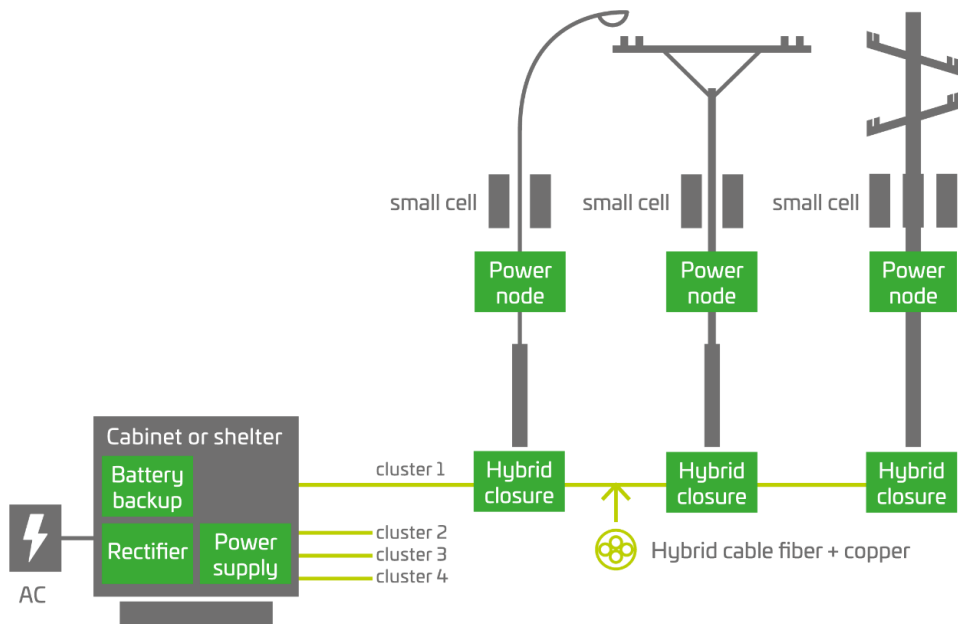

PowerShift Metro is designed to support outdoor small cells. It uses a modular power shelf with centralized battery backup to employ peak shaving, which enables MNOs to maximize power plant efficiency by pulling battery plant energy during peak traffic times, resulting in more **appropriately sizing the power plant**. Additionally, load shaping is a function that allows MNOs to simultaneously run network elements using both power plant and battery plant power to reduce energy consumption during peak delivery cost periods, recharging the battery plant during lower cost periods.

Our PowerShift Macro solutions deliver dynamically regulated voltage to tower-top RRUs. As RRU power consumption or feed cable length increases, PowerShift improved efficiency compared to fixed boost (up to ~5% better) or no boost architectures (up to ~10%).



You can read more about the role of power management and CommScope's solutions—including PowerShift Metro and PowerShift Macro—in the *Powering wireless networks eBook*.

Sustainable manufacturing processes

We embrace every angle of the circular economy

The circular economy is the philosophy of bringing products into the market more thoughtfully—making them operate more efficiently, ensuring they are useful for a longer time, and, at end of life, that they are recycled as much as possible. For a global company like CommScope, that puts us in a place of special responsibility.

For CommScope OVN, the circular economy is our roadmap for manufacturing

From responsible supply chains to reducing the carbon footprint of our manufacturing processes, we strive to ensure maximum reuse and recycling of our products.

A continual effort to reduce CO₂ emissions by design.

The replacement of our diesel forklifts with electric ones prevented the release in the atmosphere of

1.8 metric tons of CO₂eq

The recycling of solder dross from wave soldering machines enables 30% of original solder to be recycled and prevented the release in the atmosphere of

20 metric tons of CO₂eq

A significant reduction of liquefied petroleum gas (LPG) has been achieved thanks to the optimization of the curing oven, the wash plant and the paint system, thus preventing the release in the atmosphere of

57 metric tons of CO₂eq

The implementation of various energy saving initiatives in our Goa plant—for the management of direct power, air conditioning, lighting and compressed air—has enabled savings of 1.9 million kWh and prevented the release in the atmosphere of

1,341 metric tons of CO₂eq

Rethinking packaging and logistics

Optimizing the way we build, box and ship our solutions

CommScope does business with partners all over the world

With tons of product shipping every day to six continents, OWN has a precious opportunity to reduce the environmental impact of this important phase of business.

We are constantly working to use less material and preserve our natural resources—without diminishing the quality our partners expect from CommScope OWN solutions. These measures are making an impact now, and that will increase as we expand these practices further across our global production chain. We will also soon offer product end-of-life guidance to our partners to help them build a greener network—so, while these efforts are doing good now, they'll be even greater soon.

With 90% of world trade moving aboard 90,000 cargo ships—which themselves are responsible for 2% of CO₂ emissions worldwide—we have focused on using less space, less material and less weight to reduce this impact.

“...while these efforts are doing good now, they'll be even greater soon.”



Tangible benefits achieved in 2023

We redesigned our packaging

To reduce GHG emissions, we have replaced the Instapak® foam cushion with corrugated cardboard solution for our rectifiers PS-1600. The corrugated cardboard generates 4.5 times less GHG emissions than the foam cushion, considerably reducing the Global Warming Potential (GWP).

Since the implementation of the new packaging design in May 2023, we have saved the release of 62 metric tons of CO₂eq.

Replacing the existing cable protection in PVC with EPE foam tube for carton packaging and PP corrugated conduit for reel packaging means a significant improvement in terms of recyclability.

The new design of the hybrid trunk cable reels has increased the durability by replacing wood with plastic. By reducing the size of the reel and eliminating the reel transportation support, we could increase the trailers' loading rate by 470% and reduce emission by 3.6 times. Since its implementation in July 2023, we have saved 210 kg of CO₂eq.

By rethinking packaging and logistics, we have been able to achieve considerable improvement in container utilization—up to +16%—for our BSAs, HELIAX connectivity solutions and microwave antennas. Since its implementation for the entire Goa plant, in 2023, this has contributed to avoiding the use of 251 containers, saving 461 metric tons of CO₂eq.

We optimized our shipping approach to reduce our shipping footprint

As part of our effort to optimize our shipping approach, we decided to ship our BSAs manufactured in China directly to our distribution center in Europe, eliminating the land route by truck, resulting in 1,500 km saved per container. Since its implementation in July 2023, this has contributed to save 18.3 metric tons of CO₂eq.

Extending product lifecycles

Building for the future starts with building for the long term

A key element of the circular economy is to ensure that, for any investment of energy and materials, we realize the maximum benefit possible, for the longest time possible.

CommScope OWN has always made long lifespans a core value of our solutions, but it's not just about saving costs—it's also about saving the planet.

OWN strives to build antennas, cables, connectors, enclosures and other components that will serve our partners' networks for years to come—through the seasons and through the inevitable evolution of technologies.

We build for modular adaptability and the capacity to flex and grow. And, of course, we build for maximum possible durability and reliability because that's always been part of who we are.

“...it's not just about saving costs—it's also about saving the planet.”

Our modular approach

CommScope OWN helps operators deploy exactly what's needed and expand when ready.

- Our new **Mosaic®** solution combines active and passive antennas in a single slim form factor, enabling operators to **exchange RAN solutions without replacing passive components.**
- Our **modular CMC equipment enclosures** offer multiple options for thermal management and flexibility to incorporate batteries for power back-up.
- Our **stackable HELIAX SkyBlox breakout solution**, made from recyclable polycarbonate, can be deployed up to four units high to facilitate power and fiber connectivity to FTTA sites. It's designed to help operators **deploy what they need, when they need it, and grow over time without ripping and replacing existing components.**
- Expandable and stackable solutions offer **the most low-impact way to grow network coverage and capacity.**

Lasting longer, adapting better

Our solutions are engineered to last longer and adapt better, even under harsh conditions.

- Our trusted **HELIAX solutions come with 10-year warranties** and are commonly in service for twice that long—or even longer.
- Our solutions offer superior reliability, **reducing the resources needed** to configure, maintain and repair them.
- **SkyBlox is a stackable, scalable solution** that can handle various diameter power cords, extending its usefulness even as site components evolve and are changed out.

Designed to be rebuilt

In the United Kingdom, CommScope's Professional Services team has already **refurbished more than 200 old site cabins**, restoring them to like-new operational condition for just a fraction of the materials and energy required to replace them—**extending their lifecycle and keeping materials out of landfills.**

We pave the path to new standards and network technologies.

CommScope OWN solutions support LTE and 5G networks with 4T4R/4T8R and FDD 8T8R, respectively—and we also provide clear and reliable migration paths to let them evolve as technology standards and market needs dictate.

COMMSCOPE®

www.commscope.com

©2024 CommScope, LLC. All rights reserved. CO-117232.2-EN (11/24)